

Pietranera Arco/Arco All Dimensions

ARCO-ALL Pag. 2-3-4-5

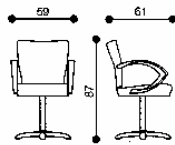

31A.3R

- Poltrona girevole
- Swivel chair
- Fauteuil tournant
- Drehstuhl
- Butaca giratoria

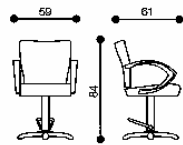

31A.6R

- Poltrona idraulica non bloccabile
- Hydraulic non-lockable chair
- Fauteuil hydraulique sans blocage
- Hydraulischer Stuhl ohne Dreharretierung
- Butaca hidraulica sin bloqueo

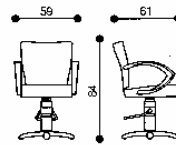

31A.7R

- Poltrona idraulica bloccabile
- Hydraulic lockable chair
- Fauteuil hydraulique avec blocage
- Hydraulischer Stuhl mit Dreharretierung
- Butaca hidraulica con bloqueo

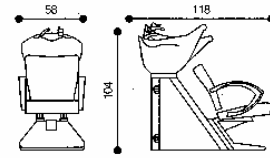

31ALB

- Lavaggio con struttura in acciaio
- Shampoo unit with steel structure
- Bac de lavage avec structure en acier
- Wascheinheit mit Stahlwänden
- Lavacabezas con estructura en acero

ARCO Pag. 6-7-8-9

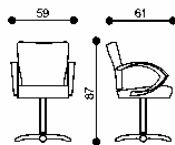

31.3R

- Poltrona girevole
- Swivel chair
- Fauteuil tournant
- Drehstuhl
- Butaca giratoria

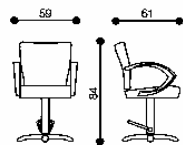

31.6R

- Poltrona idraulica non bloccabile
- Hydraulic non-lockable chair
- Fauteuil hydraulique sans blocage
- Hydraulischer Stuhl ohne Dreharretierung
- Butaca hidraulica sin bloqueo

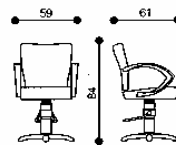

31.7R

- Poltrona idraulica bloccabile
- Hydraulic lockable chair
- Fauteuil hydraulique avec blocage
- Hydraulischer Stuhl mit Dreharretierung
- Butaca hidraulica con bloqueo

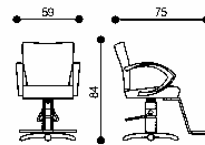

31.7R.43

- Poltrona idraulica con poggiatesta
- Hydraulic chair with footrest
- Fauteuil hydraulique avec repose-pieds
- Hydraulischer Stuhl mit Fußstütze
- Butaca hidraulica con apoyapie

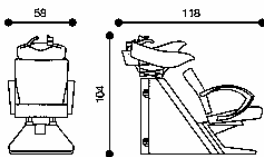

31LA

- Lavaggio con struttura in acciaio
- Shampoo unit with steel structure
- Bac de lavage avec structure en acier
- Wascheinheit mit Stahlwänden
- Lavacabezas con estructura en acero

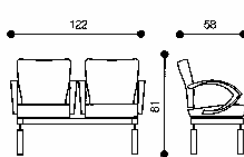

31.102

- Panchetta attesa 2 posti
- 2 Seater waiting bank
- Banquette d'attente à 2 places
- 2 Sitzige Wartebank
- Butaca de espera de 2 puestos

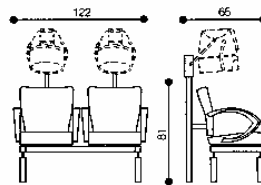

31.102.78

- Panchetta portacasco 2 posti
- 2 Seater dryer bank
- Banquette porte-casque à 2 places
- 2 Sitzige Trockenbank
- Butaca portacasco de 2 puestos

Above dimensions are in centimeters.

Arco All Shampoo System: 22 7/8 inches W x 46 1/2 inches D x 41 inches H

The plumbing area space beneath the shampoo bowl: 8 1/2 inches W x 11 inches D x 26 inches H

The Italian fixtures do not have space for a vacuum breaker. If you are required to have a vacuum breaker, install a back flow preventer system or order the optional (\$50.00 upcharge) American certified plumbing fixture with a built-in vacuum breaker.

Location of fixing holes
measurements in millimeters

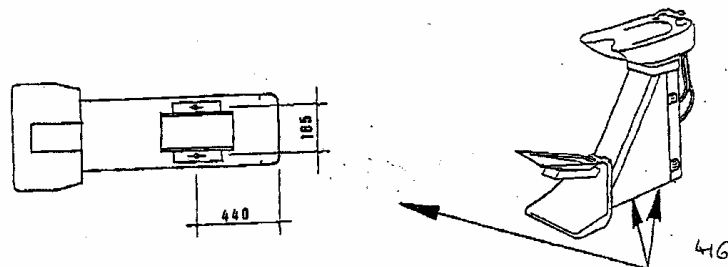

Positioning of hair trap

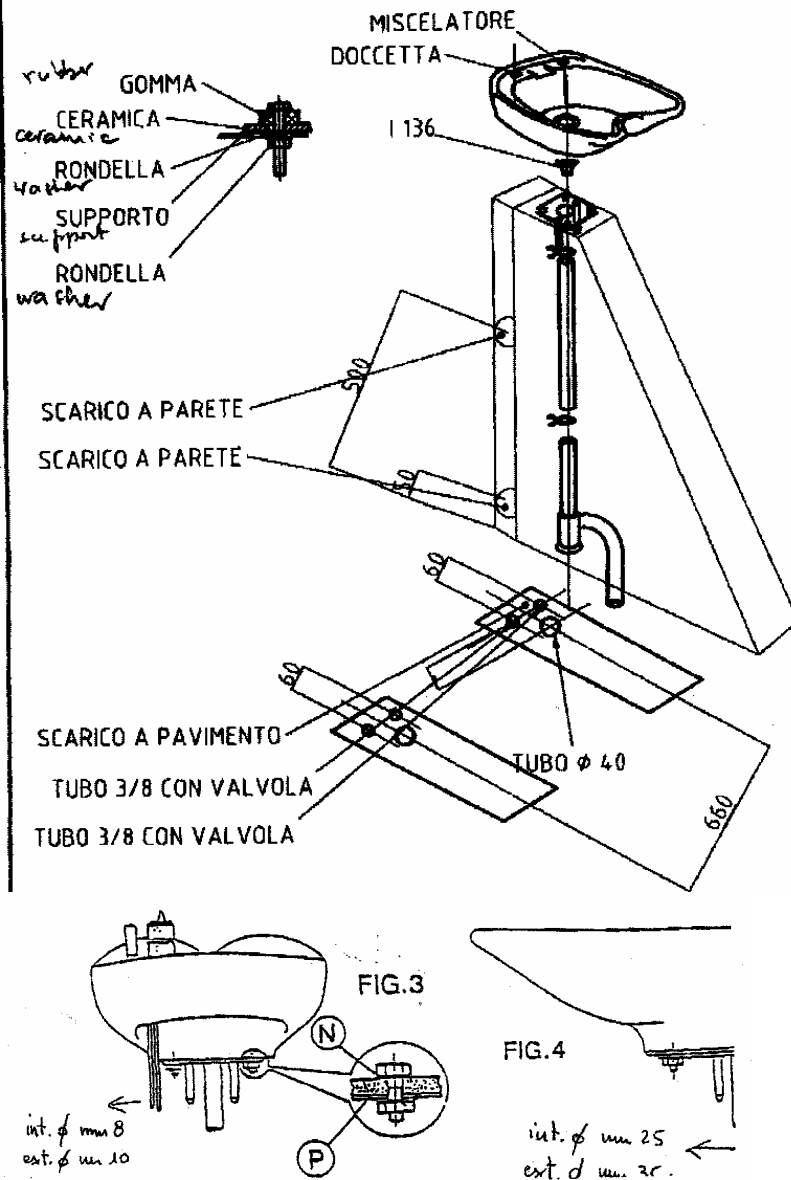

Mounting Instructions:

1. Determine the correct working position of the shampoo unit.
2. Remove the back panel and fix the shampoo unit to the floor through the slots in the base.
3. Fix the water mixer and the outlet pipe to the basin.
4. Connect the plate (P) to the basin with the brass screws. The rubber washer (N) should be placed inside the basin.
5. Fit the transparent plastic pipe to the bottom of the outlet pipe.
6. Fit the basin assembly to the unit.
7. Connect the mixer pipes, by bending them, to the cold and hot water pipes of the piping system, by means of the fastenings.
8. Reassemble the back panel to the shampoo unit.

Pietranera Hedera Shampoo System dimensions

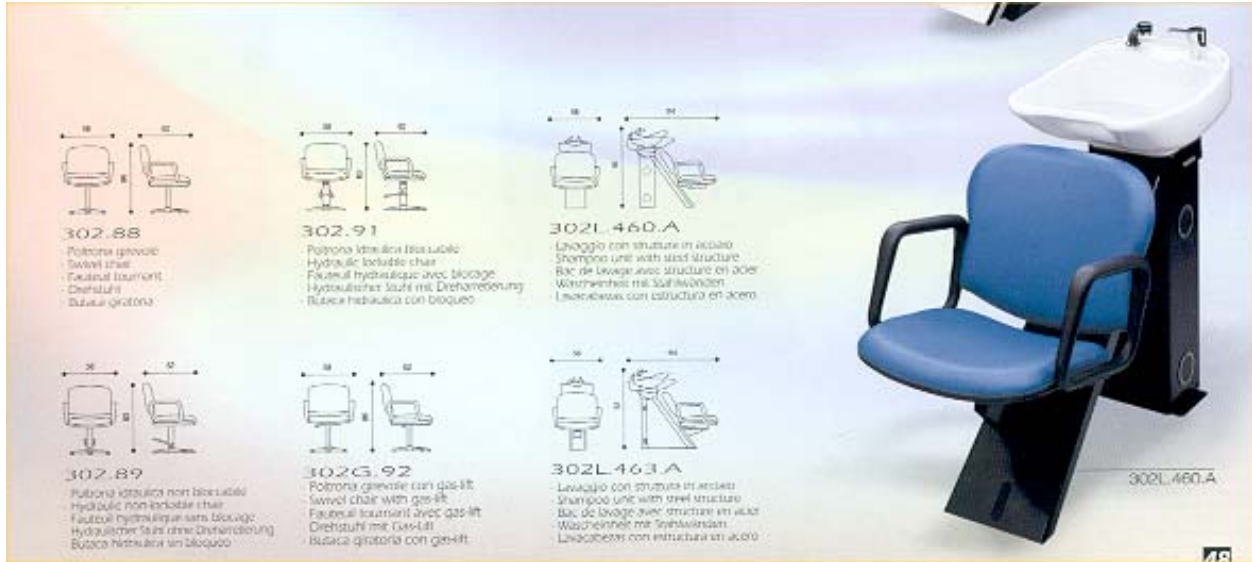

Above dimensions are in centimeters.

Hedera Shampoo System: 22 7/8 inches W x 44 7/8 inches D x 36 1/4 inches H

The plumbing area space beneath the shampoo bowl: 8 1/2 inches W x 6 3/4 inches D x 27 inches H

The Italian fixtures do not have space for a vacuum breaker. If you are required to have a vacuum breaker, install a back flow preventer system or order the optional (\$50.00 upcharge) American certified plumbing fixture with a built-in vacuum breaker.

3 1/2 inch diameter access holes are located on the side the shampoo bowl column, at 4 inches and 20 inches from the floor.

Positioning of hair trap

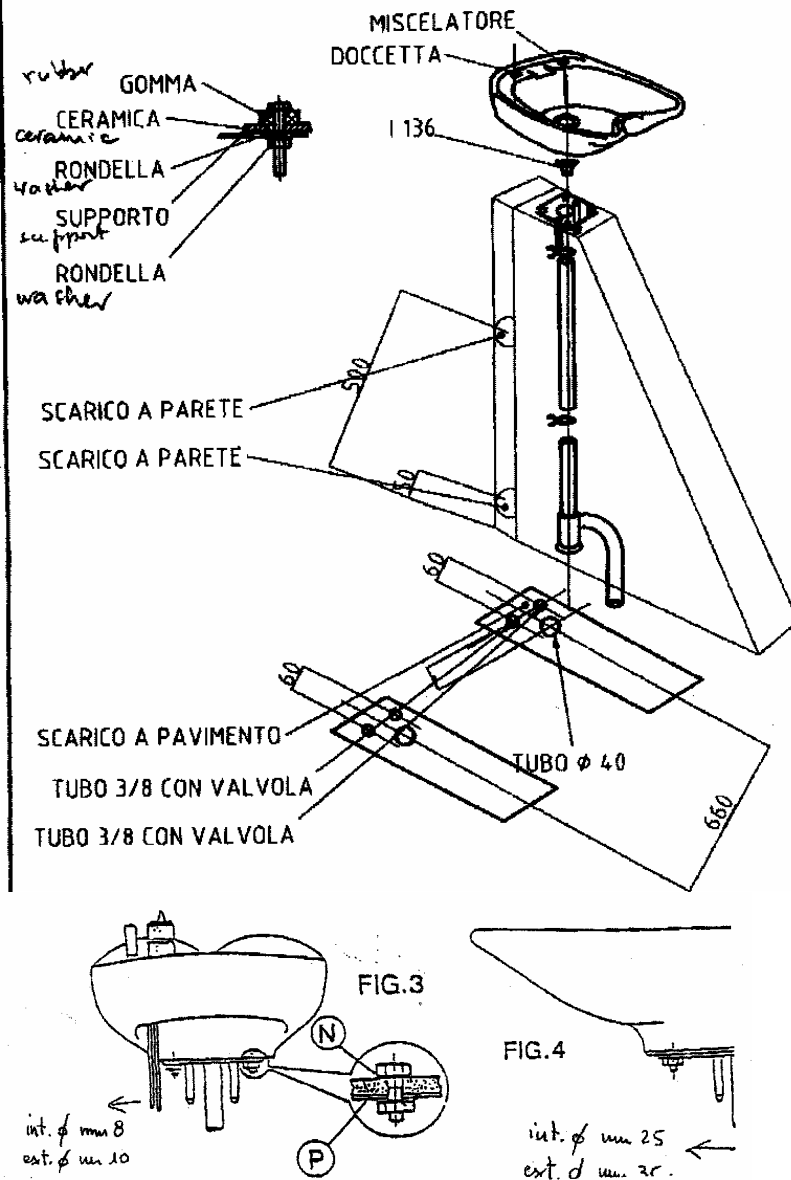

Mounting Instructions:

1. Determine the correct working position of the shampoo unit.
2. Remove the back panel and fix the shampoo unit to the floor through the slots in the base.
3. Fix the water mixer and the outlet pipe to the basin.
4. Connect the plate (P) to the basin with the brass screws. The rubber washer (N) should be placed inside the basin.
5. Fit the transparent plastic pipe to the bottom of the outlet pipe.
6. Fit the basin assembly to the unit.
7. Connect the mixer pipes, by bending them, to the cold and hot water pipes of the piping system, by means of the fastenings.
8. Reassemble the back panel to the shampoo unit.